



**Edelbrock E-Force Supercharger**  
**For: 2009-2017 Dodge/RAM 1500 Truck 5.7L V8 HEMI**  
**PN: 1538, 15380, 15175**





## **WARNING!**

*The supercharger bypass valve is factory installed and adjusted intended to be vacuum operated only. DO NOT move the solenoid actuator lever by hand or adjust the stop point. Moving the lever manually will damage the solenoid and the system will not function properly. Damage to the bypass assembly from manual movement will not be covered under manufacture warranty.*



# IMPORTANT CALIBRATION DETAILS



## 2015-2017 Vehicles ONLY

### **USA CUSTOMERS ONLY:**

*In order to properly calibrate your vehicle for this supercharger kit, the ECM must be removed from the vehicle, packaged and shipped to Edelbrock. Your vehicle's computer will be modified and or flashed for supercharger kit compatibility. PN 15175 contains a box for shipping the ECM to Edelbrock. (See ECM removal procedures on the following pages.)*

**NOTE:** *Please email your Name, Address, phone number and email address to [ECMCalibration@Edelbrock.com](mailto:ECMCalibration@Edelbrock.com) and a prepaid return label will be sent. Affix the label to the package and drop it off at any UPS Store in your area.*

*The calibration process will take approximately 5 business days from the time your vehicles computers are received. To avoid unplanned vehicle down time, we recommend that the computers be shipped out BEFORE beginning the supercharger installation.*

***INTERNATIONAL (NON-USA) CUSTOMERS PLEASE CALL EDELBROCK TECHNICAL SUPPORT AT (800)-416-8628.***

# ECM Removal

The ECM is located under the hood, on the passenger side of the vehicle, behind the factory airbox. Follow these instructions carefully to remove, package and ship the ECM to Edelbrock.

1. Using a 10mm socket, remove the negative battery terminal. Isolate the cable so it does not come in contact with the terminal or body of the vehicle.



2. Push in the black locking tab and lift up the red clasps on the ECM harness connectors and remove them from the ECM.

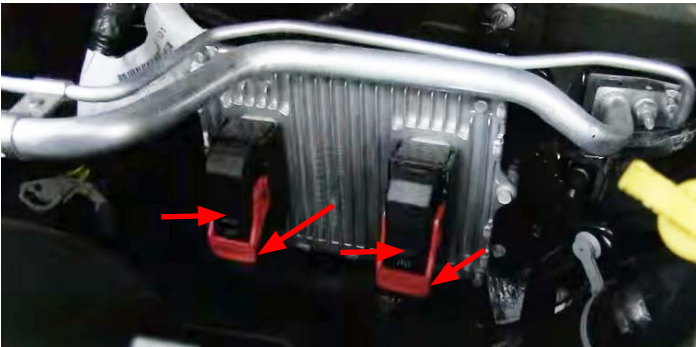

3. Using a 10mm socket, remove the three (3) bolts securing the ECM to its bracket.



4. Fill out the provided calibration label with customer and vehicle information and apply the label directly to the ECM. Place the ECM in the provided box with packing material so the ECM cannot move around in the box. Ship ECM to Edelbrock using the provided return shipping label.



Installation Instructions

**2009-2014 VEHICLES ONLY:** PLEASE COMPLETE THIS PROCEDURE PRIOR to starting the installation of your E-Force supercharger system. This will allow our calibration team to complete your calibration file while the installation of your supercharger system is being completed. Manufacturers regularly update the factory calibration, as a result, there is the possibility for delays due to not having access to your current calibration file. This can normally be resolved in 1 business day.

**FAILURE TO PROVIDE ALL OF THE INFORMATION BELOW WILL DELAY THE COMPLETION OF THE CALIBRATION FILE FOR YOUR VEHICLE. TO LIMIT VEHICLE DOWN TIME, PLEASE SEND US THE REQUESTED INFORMATION BEFORE STARTING THE SUPERCHARGER INSTALL.**

Please e-mail the requested information below to calibration@edelbrock.com with the E-mail Subject as "Calibration Update". We will complete your calibration and e-mail it back to you as soon as possible. MOST calibration updates will be sent back the same business day. In rare cases, it could take up to 1-2 business days to complete. Please contact our Tech Hot Line at (800)416-8628 if you have any questions or if you need assistance with this procedure.

**INFORMATION NEEDED:**

- E-Mail Address:
- Vehicle Year:
- Vehicle Make:
- Vehicle Model (Specify if Z06, Z51, SRT8, RT, Boss 302, etc.):
- Engine Size:
- Transmission:
- Fuel Octane (91 or 93 ONLY):
- Supercharger System Part Number:
- Supercharger Serial Number:
- Programmer Serial Number:
- ECU OS Part Number:
- ECU OS Part Type:

**INSTRUCTIONS FOR GETTING THE ECU OS PART NUMBER & TYPE:**

With the ignition OFF, connect the supplied SCT X4 Programmer to the OBDII port of the vehicle using the cable included with the SCT programmer.

Once the SCT programmer powers on, it will take you to the Main Menu. Press the down arrow to highlight the "Vehicle Info" option and press the round center button to accept.

Follow the on-screen instructions. When prompted to do so, turn the vehicle's ignition ON but do not start the engine. Press the round center button to accept. The ECU OS Part Number and Type will be displayed on the following screen.

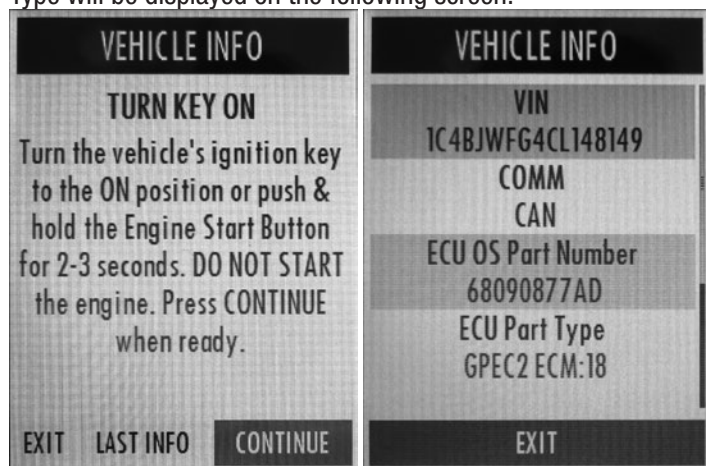



## Edelbrock E-Force Supercharger System 2009-'17 Dodge/RAM 5.7L Hemi 1500 Truck

### Installation Instructions

#### INTRODUCTION

Thank you for purchasing the Edelbrock Supercharger System for 2009-17 Dodge/RAM 1500 Trucks with 5.7L V8 Hemi engine. The Edelbrock E-Force Supercharger System utilizes Eaton's Gen VI R2300 TVS Supercharger rotors, featuring a four-lobe design with 160° of twist. The Edelbrock Supercharger is a complete system that maximizes efficiency and performance by minimizing air restriction into, and out of, the supercharger. This results in maximum airflow with minimal temperature rise and power consumption. The supercharger housing itself is integrated into the intake manifold for a seamless design with minimal components. The system also utilizes a front drive, front inlet configuration giving it the shortest, least restrictive inlet path on the market.

The supercharger is inverted, expelling the air upward. Air pressure then builds in the plenum before being pushed through the intercooler that is oriented horizontally, above the supercharger outlet. After passing through the intercooler core, the air travels through the long runners which route straight down into the cylinder head ports. This configuration allows for a compact package that fits under the stock hood and cowl of the vehicle for which it was designed without sacrificing runner length or intercooler area. The end result is a supercharger that provides neck snapping performance that is safe to operate on a completely stock engine.

#### TOOLS AND SUPPLIES REQUIRED

- Jack and Jack Stands OR Service Lift
- Panel Puller
- Ratchet and Socket Set including: 7mm, 8mm, 10mm (standard, deep and swivel), 11mm, 12mm (deep), 13mm, 15mm, 18mm, 21mm (deep), 24mm
- Wrenches including: 8mm, 18mm, 27mm
- 1/2" Breaker Bar
- Flat Blade & Phillips Screwdrivers
- Compressed Air
- 90° Power Drill
- Side Cutters
- 3/8" Fuel Line Removal Tools
- Torque Wrench
- Needle Nose Pliers
- Pliers OR Hose Clamp Removal Tool
- Impact Wrench
- Red, Blue & Green Thread Retaining Compound
- O-ring Lube
- Masking Tape
- Electrical Tape
- Flywheel/Flex plate Holder





**IMPORTANT WARNINGS**

***Before beginning the installation, use the enclosed checklist to verify that all components are present in the box then inspect each component for damage that may have occurred in transit. If any parts are missing or damaged, contact Edelbrock Technical Support (800-416-8628), not your parts distributor.***



**WARNING:** *Installation of this supercharger will result in a significant change to the performance characteristics of your vehicle. It is highly recommended that you take some time to familiarize yourself with the added power and how it is delivered. This should only be done in a controlled environment. Take extra care on wet and slippery roads as the rear tires will be more likely to lose traction with the added power. It is never recommended to turn off your vehicles traction control system.*

***Proper installation is the responsibility of the installer. Improper installation will void all manufacturer's standard warranties and may result in poor performance and engine or vehicle damage.***

***Inspect all components for damage that may have occurred in transit before beginning installation. If any parts are missing or damaged, contact Edelbrock Technical Support, not your parts distributor.***

Due to the complexity of the Edelbrock E-Force Supercharging system, it is recommended that this system only be installed by a qualified professional with access to a service lift, pneumatic tools, and a strong familiarity with automotive service procedures. To qualify for the optional supplemental warranty, it is necessary to have this system installed by a Certified ASE Technician at a licensed business, Dodge/Chrysler Dealership, or an Authorized Edelbrock Installer. Failure to do so will void and/or disqualify any and all optional supplemental warranties offered with this system. Please contact the Edelbrock Technical Support department if you have any questions regarding this system and/or how your installer of choice will affect any warranty coverage for which your vehicle may qualify.

***Any previously installed aftermarket tuning equipment must be removed and the vehicle returned to an as stock condition before installing the supercharger.***

Any equipment that directly modifies the fuel mixture or ignition timing of the engine can cause severe engine damage if used in conjunction with the Edelbrock E-Force Supercharger System. This includes, but is not limited to: OBDII programmers, MAF sensors, adapters and any other device that modifies signals to and/or from the ECU. Aftermarket bolt-on equipment such as underdrive pulleys or air intake kits will also conflict with the operation of the supercharger and must be removed prior to installation. Use of any of these products with the E-Force Supercharger could result in severe engine damage.



**IMPORTANT WARNINGS cont'd**

**Please employ proper towing etiquette when towing steep grades. Turn off Air Conditioner and avoid aggressive towing behaviors to avoid any overheating that may occur. DO NOT exceed the manufacturer's maximum tow rating for the vehicle.**



**91 octane or higher gasoline is required at all times. If your vehicle has been filled with anything less, it must be run until almost dry and refilled with 91 or higher octane gasoline twice prior to installation.**

**Any failures associated with not using premium 91 octane gasoline or higher, will be ineligible for warranty repairs.**

***It recommended that you check the Edelbrock Tech Center Website for any updates to this installation manual. Please refer to the lower right hand corner to verify that you have the latest revision of this installation manual before beginning the installation.***

***Tech Center: [http://www.edelbrock.com/automotive\\_new/misc/tech\\_center/install/index.php](http://www.edelbrock.com/automotive_new/misc/tech_center/install/index.php)***

**Edelbrock Authorized Installer Disclaimer**

*Authorized installers of Edelbrock products are independent companies over which Edelbrock has no right of control. Edelbrock LLC makes no claims regarding the abilities, expertise or competency of individual employees of any authorized installer. Each authorized installer is an independent company and makes its own independent judgments. Edelbrock LLC specifically disclaims any responsibility to any party including third parties for the actions, or the failure to act, of individuals, agents or a company authorized in the installation of Edelbrock LLC products.*

### INSTALLATION HARDWARE IDENTIFICATION GUIDE

(Parts Are Not To Scale)

BAG #1 - MANIFOLD/FUEL RAIL HARDWARE				
Item	P/N	QTY.	Description	Torque Spec.
1	36-1567	4	Bolt, Hex Flange, M6 x 50mm	7-9 Ft-Lbs.
2	36-4053	4	Bolt, Hex Flange, M6 x 40mm	7-9 Ft-Lbs.
3	36-1508	12	Bolt, Hex Flange, M6 x 30mm	9 Ft-Lbs.
4	51-4093	1	Throttle Body O-Ring	N/A
5	74-8500	1	Bypass Spring	N/A
6	70-3503	1	.05" Taper Face Jet	N/A

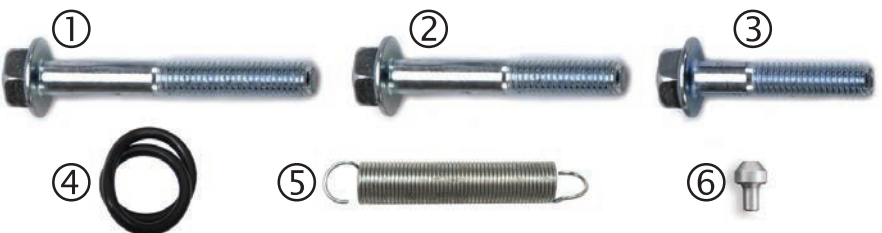

BAG #2 - INTERCOOLER HARDWARE				
Item	P/N	QTY.	Description	Torque Spec.
1	36-1545	1	Bolt, Hex Flange, M6 x 12mm	7 Ft-Lbs.
2	36-1552	8	Bolt, Hex Flange, M6 x 10mm	7 Ft-Lbs.
3	36-1512	1	Bolt, Button Head, M8 x 10mm	17 Ft-Lbs.
4	36-1519	1	Bolt, Hex Flange, M8 x 40mm	17 Ft-Lbs.
5	36-1518	1	Bolt, Hex Flange, M8 x 30mm	17 Ft-Lbs.
6	60-1515	1	M10 Hex Flange Nut	17 Ft-Lbs.
7	36-8572	1	M8 Hex Flange Nut	7 Ft-Lbs.
8	24-4256	1	1" Spacer	N/A
9	24-1538	1	1/4" Spacer	N/A
10	52-4199	2	Push Pin	N/A
11	46-2155	8	3/4" Hose Clamp	N/A

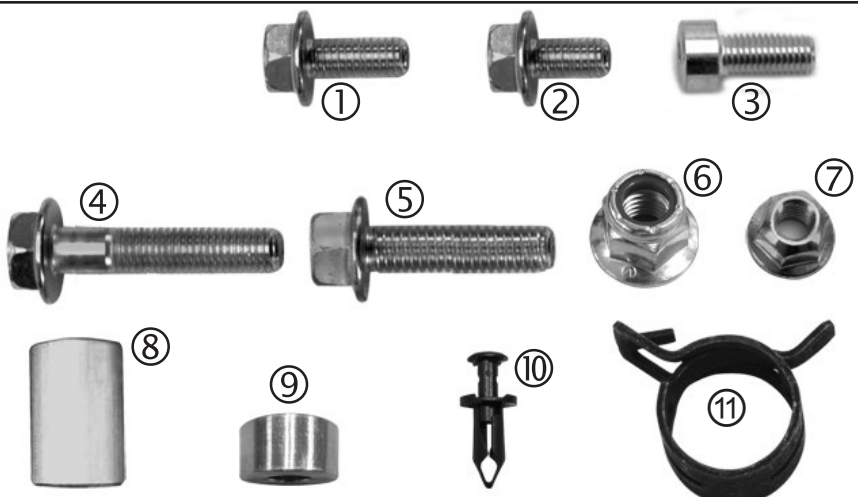

BAG #3 - DRILL GUIDE HARDWARE				
Item	P/N	QTY.	Description	Torque Spec.
1	51-7096	1	1/4" x 1/2" Steel Dowel	N/A
2	51-7046	1	15/64" Steel Drill Bit	N/A
3	51-7047	1	.2500" Reamer	N/A
4	36-4049	1	Bolt, M14 x 100mm (Not Shown)	127 Ft/Lbs.
5	24-1591	1	Drill Fixture/Guide	N/A



### INTERCOOLER / PCV HOSE IDENTIFICATION GUIDE

*(Hoses Are Not To Scale)*

INTERCOOLER / PCV HOSES			
Item	P/N	QTY.	Description
1	51-4200	1	Hose, LTR to Manifold
2	51-4170	1	Hose, Tank to WP
3	51-4169	1	Hose, Manifold to Tank
4	51-4199	1	Hose, WP to LTR
5	56-1602	1	Passenger Side PCV - 18"
6	22-1639	1	Hose, Manifold To EVAP
7	51-4183	1	Driver Side PCV to Airbox
8	56-1602	1	Hose, EVAP - 39"

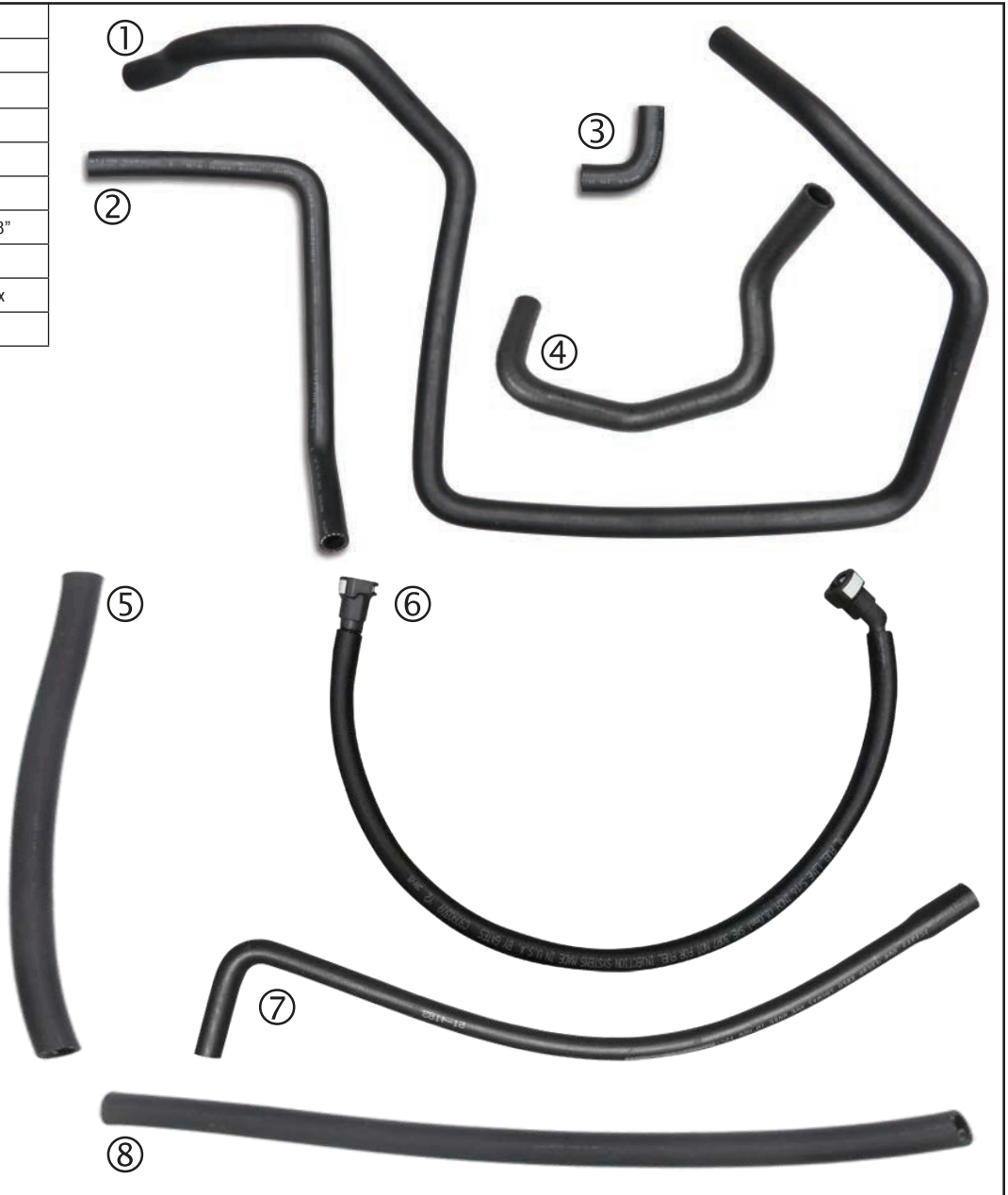

### BRACKET IDENTIFICATION GUIDE

(Parts Not To Scale)

LTR AND WATER PUMP BRACKETS			
Item	P/N	QTY.	Description
1	79-9173	1	Upper Driver Side LTR
2	79-9174	1	Upper Passenger Side LTR
3	79-9177	1	Recovery Tank Bracket
4	79-9175	1	Lower Passenger Side LTR
5	38-2959	1	EVAP Bracket
6	79-9177	1	AC Line Support
7	79-9178	1	Water Pump Bracket

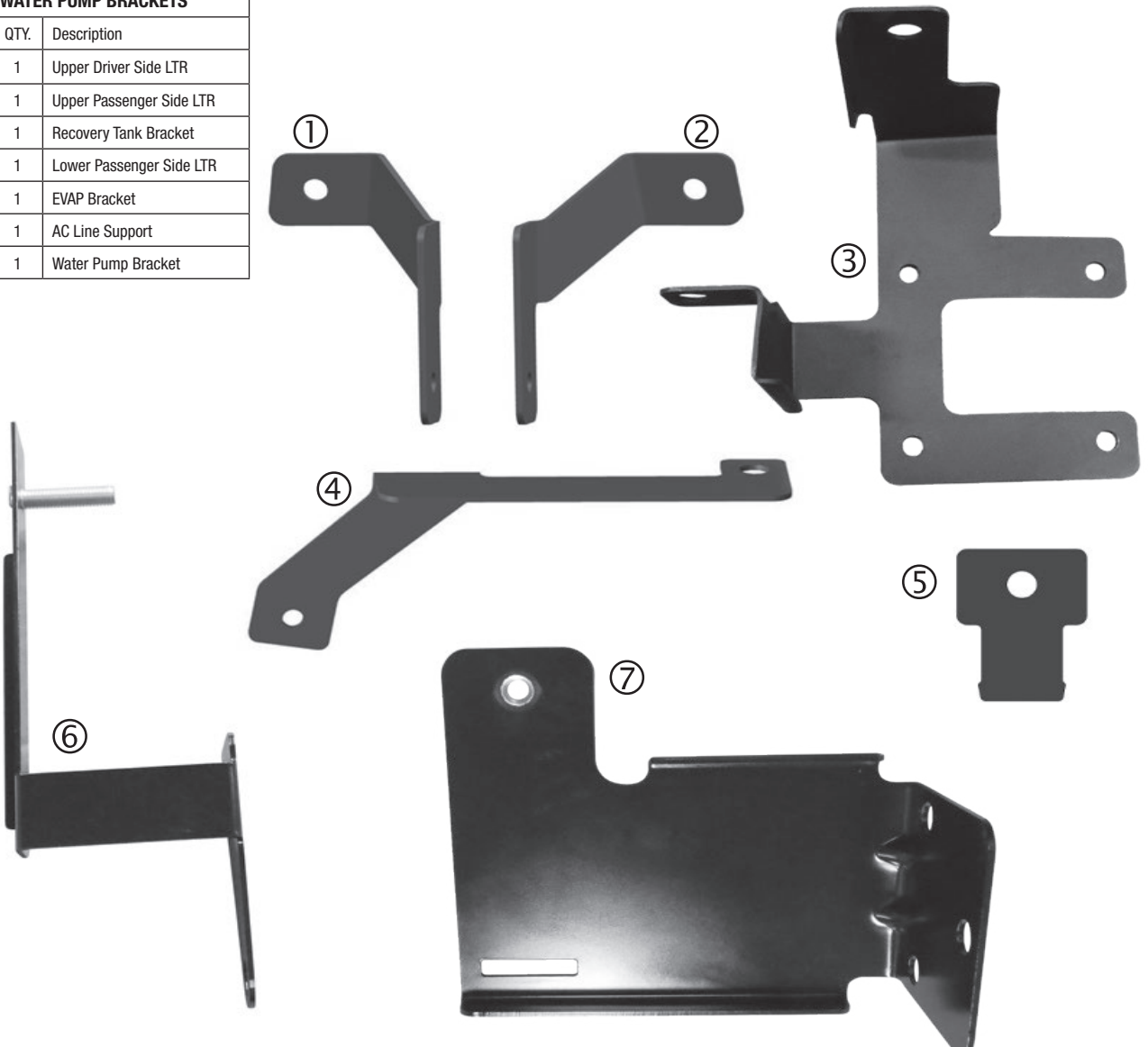

#### WIRE HARNESS IDENTIFICATION GUIDE

*(Parts Are Not To Scale)*

WIRE HARNESSES			
Item	P/N	QTY.	Description
1	37-6657	1	Map Sensor Harness
2	37-1913	1	Micro2 Fuse Tap
3	37-6655 37-6700	1	IAT Extension Harness (PN 1538 & 15380 Includes two different extensions)
4	37-1603	1	Water Pump Harness
5	37-3727 37-6626	1	ECT Extension Harness (PN 1538 & 15380 Includes two different extensions)



**HOSE ROUTING AND INTERCOOLER FLOW DIAGRAM**

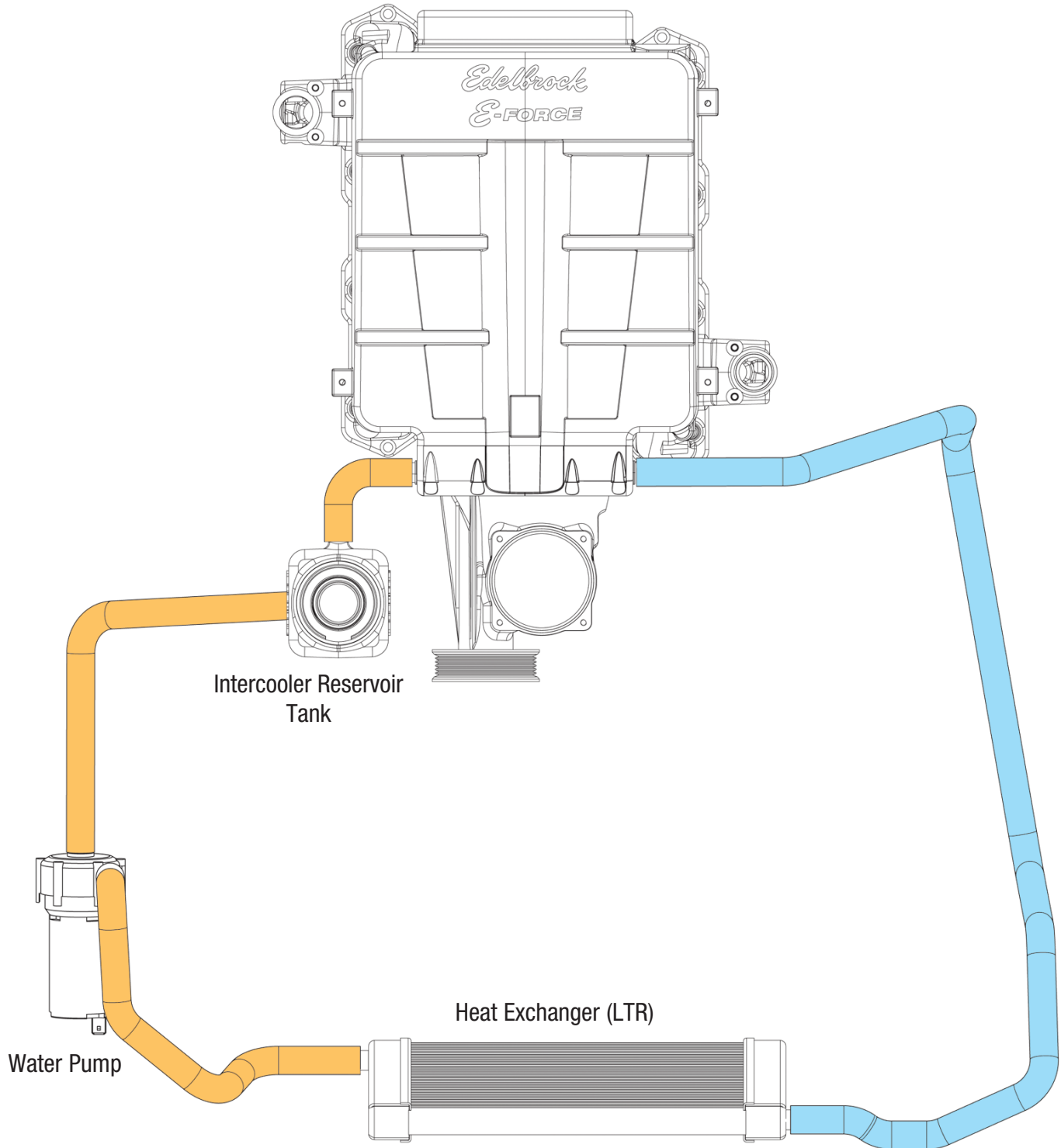

### Installation Instructions

#### Supercharger Installation

**Steps 1-13 are for 2009-2014 vehicles only. 2015+ vehicles only need to reinstall the ECM upon being returned from Edelbrock. The computer has already been recalibrated for this supercharger system. After the computer is reinstalled, secure the provided OBDII "DO NOT FLASH" cover onto the OBDII port.**

**WARNING: Battery must be sufficiently charged before starting the ECM flashing procedure.**

**Only begin the ECM flashing procedure when you have downloaded the calibration file from the Edelbrock Calibration Team to the handheld programmer. Do not flash the ECM until you are ready to install the supercharger. Once the ECM is flashed, DO NOT START the engine until the installation of the E-Force supercharger is complete.**

1. Put the car into ACC mode, but don't start the vehicle.
2. Connect the supplied ECM cable on the handheld programmer to the OBD-II connector located below the steering wheel, and to the left of your knee.
3. Use the directional pad to highlight the Program Vehicle option and press the Select button.

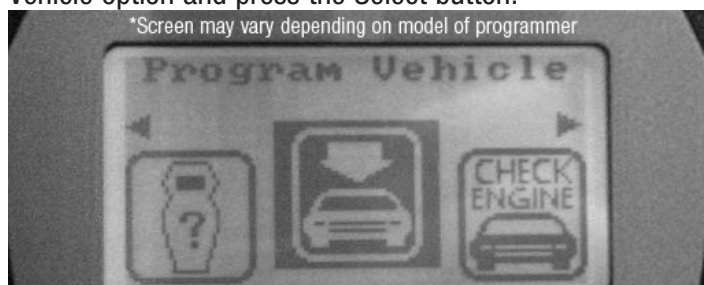

4. Use the directional pad to highlight the Pre-programmed Tune option and press the Select button.
5. Read the disclaimer then press Select to continue.
6. Verify that the ignition is in the 'Key On' position and that the engine is not running, then press Select.
7. Use the directional pad to highlight your vehicle and transmission combination then press Select.
8. Use the directional pad to highlight the Begin Program option then press Select.

9. Depending on your specific drivetrain configuration, several separate operations may take place during this step. Completion of each operation will cause the progress bar to reset to zero.

10. DO NOT unplug the programmer until prompted.

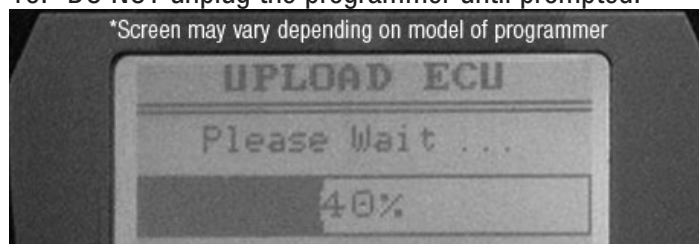

11. Turn the vehicle off when prompted to do so by the handheld programmer.

12. Read the parting message from programmer then press Select to continue.

13. Unplug the programmer cable from the OBD-II port. This concludes the ECM flashing procedure. DO NOT start the engine until the supercharger installation is complete.

14. Using a 10mm socket, remove the negative battery terminal.



15. Using a panel puller, CAREFULLY remove four (4) small body pins (RED ARROWS) and two (2) large body pins (BLUE ARROWS) securing the radiator cover.





### Installation Instructions

16. Using a 10mm socket, remove four (4) bolts securing the grill.

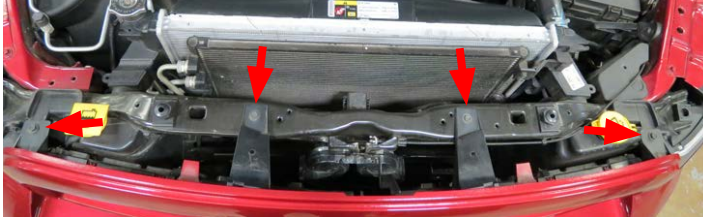

**NOTE:** Depending on your model year, the grill will detach from the vehicle differently.

17. Earlier model years will detach two (2) metal retaining clips (BLUE ARROWS) and two (2) plastic retaining clips (RED ARROWS). Later model years will detach one (1) center tab and four (4) plastic push pins. Detach grill appropriately and remove.

#### Earlier Model Years



#### Later Model Years

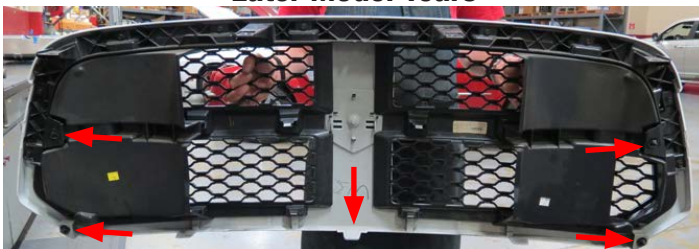

18. Slide the red locking clasp outward and unplug the intake air temp sensor from the intake tube. Remove the intake tube from the throttle body and airbox using a flathead screwdriver. Remove the engine cover and set aside.



**NOTE:** Depending on your model year, the fuel line will detach from the fuel rail differently.

**WARNING:** Fuel may be under pressure. Make sure to cover fuel line with a shop rag to prevent fuel from spraying.

19. Earlier model years need to remove the fuel safety clip from the fuel feed line then disconnect the fuel feed line from the fuel rail using a 3/8" fuel line removal tool. Later model years need to lift up the red locking tab and then depress the red locking tab from both sides to remove the fuel line. Regardless of model year, always cap the fuel rail to avoid excess fuel spillage.

#### Earlier Model Years



#### Later Model Years



20. Slide the red locking clasp outward and unplug the throttle body connector from the throttle body.



21. Remove the driver side PCV hose from the intake airbox and driver side valve cover. This hose will not be reused.



### Installation Instructions

22. Remove the passenger side PCV hose from the barb under the throttle body. The hose will be removed with the manifold and not reused.



**NOTE:** Vehicles with EVAP solenoids mounted on the driver side fender proceed with Step 23. Vehicles with EVAP solenoids mounted on the manifold skip Step 23 and proceed with Step 24-25.

23. Remove the EVAP hose from the manifold and from the EVAP solenoid. Proceed to Step 26.

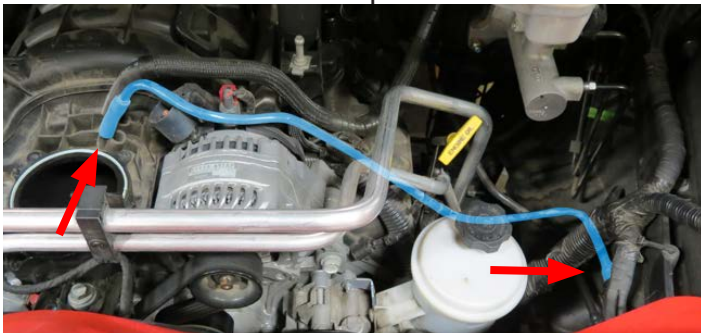

24. Remove the EVAP hose from the EVAP solenoid and from the barb located on the firewall below the brake booster.



25. Unplug the EVAP solenoid connector and disconnect the second EVAP hose from the solenoid. Remove the EVAP solenoid from the manifold and set aside as it will be reused later but the hose will not.



26. Remove the brake booster hose from the manifold.



27. Slide the red locking clasps outward and unplug all eight (8) fuel injector connectors .



28. Using a small flat head screwdriver, or equivalent, remove the support strap from the A/C lines and set aside.



### Installation Instructions

29. Use a 13mm socket to remove the bolt and nut securing the A/C line support strap.

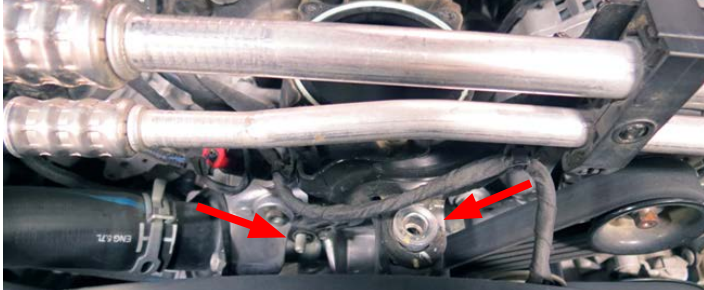

30. Slide the red locking clasps outward and unplug the Active Runner connector and the Map sensor connector. Detach two harness clips behind the manifold (some vehicles have one).



31. Use an 8mm socket to remove ten (10) manifold bolts. Carefully lift the manifold over the A/C lines and remove the manifold.



32. Use a clean shop rag to wipe down the intake flange on both cylinder heads. Apply masking tape to the head ports to prevent any dirt or debris from entering the ports.



33. Using a 3/8" breaker bar, release the tension from the belt tensioner and remove the drive belt.

34. Unplug the harness connector from the alternator. Using a 13mm socket, remove the alternator power cable. Using a 15mm socket, unbolt the alternator and remove.



35. Use a 10mm socket (13mm on some vehicles) to remove the support bar behind the alternator bracket.



36. Use electrical tape to tape up the Active Runner Control connector to prevent any water from contacting the connector terminals.



37. Using a 10mm socket, remove two (2) bolts securing each ignition coil. Remove the coils, noting their orientation, so that they can be reinstalled in the same order.



### Installation Instructions

38. Using a 5/8" spark plug socket, remove all 16 spark plugs. Inspect and replace as needed. Stock plugs must be gapped to .035". Apply anti-seize to the threads of each plug and reinstall. Torque each spark plug to 13 ft/lbs.

39. Using the stock bolts, reinstall the ignition coils in the same location they were originally.

40. Raise the front of the vehicle with a service lift or equivalent. Using an 18mm socket, carefully loosen the petcock bolt to drain about a gallon of coolant. Tighten petcock bolt. *TIP: Petcock located on lower driver side of the radiator.*

41. Use a 10mm socket to remove the starter cover. Unplug the starter connector and remove the starter power cable with a 13mm socket. Use a 15mm socket to unbolt the starter and remove.

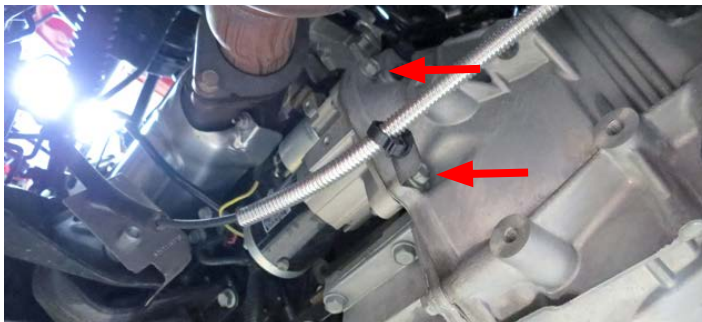

42. Install an appropriate flywheel/flexplate holding tool to prevent the engine from turning.

43. Carefully detach the lower fan shroud and set aside.



44. Using a panel puller, detach the splash guard from the fan shroud. *TIP: Push pins do not have to be removed.*



45. Lower the vehicle and remove the upper radiator hose using an appropriate hose clamp tool.

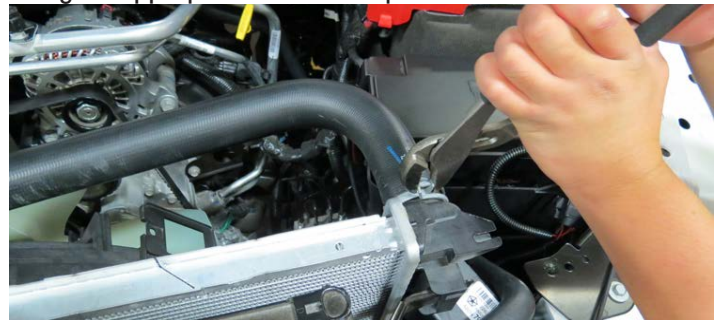

46. Disconnect the electronic fan connector.



47. Using a 13mm socket remove two (2) bolts securing the fan shroud.



### Installation Instructions

48. Carefully pull the fan shroud up to detach it from the locking tabs. Position the shroud rearwards. DO NOT attempt to remove the shroud at this time as it will not clear the mechanical fan. Remove the clips on the top and center of the fan assembly, then depress the plastic retaining clips on each side of the electric fan assembly and pull upwards to detach the fan assembly from the radiator.



49. With the electric fan detached from the radiator, carefully remove the electric fan and shroud assembly.



50. Using a 21mm socket and a breaker bar, remove the crank bolt.

51. Using the supplied M14 bolt from Bag #4, install the drilling guide with the flat side facing outwards. Position the drill bushing in a comfortable position for drilling.



52. Mark the supplied drill bit 1.5" from the end of the tip with masking tape. Using the drilling bushing as a guide, drill the crank until the tape mark on the drill bit meets the drilling guide.

53. Use compressed air to clean out any debris present from the drilling procedure.

**CAUTION:** Use extreme caution when doing this to make sure debris does not get past the seal into the crankcase as this will require a great deal of disassembly to correct or could cause severe engine damage if ignored.

54. Loosen the guide bolt and rotate the drilling guide to line up the reaming hole with the hole drilled. Use the back of the supplied reamer to center the reaming hole to the drilled hole. Tighten down the crank bolt to secure the drilling guide and ream the hole with the supplied reamer.

55. Remove the drilling guide and clean out the hole in the crank with compressed air. Apply Green Loctite to the supplied crank pin and tap it into the hole in the crank (*Red Loctite can be used if Green Loctite is not available*).

56. Using a 21mm socket, reinstall the factory crank bolt and torque to 127 ft/lbs. Reinstall the starter and torque bolts to 50 ft/lbs. Reinstall the starter cover and lower fan shroud.

57. Reinstall the electric fan and fan shroud.

58. Connect the supplied MAP Harness Extension to the factory MAP harness connector as it is difficult to do so after the manifold is on.

### Installation Instructions

**NOTE:** For improved drivability, please follow the following procedure carefully. (Photos are for reference only and may not represent actual parts or part locations.)

A. 2009-2010 Applications: Remove the hose from the actuator barb. Using the supplied jet from Bag #1, install the jet (stem end), into the actuator barb. Reinstall the actuator hose to secure the jet.

#### 2009-2010 Applications



B. 2011+ Applications: Install the supplied spring from Bag #1 to the actuator bracket and set the spring to Level 2. If you find that the boost engagement level is too aggressive for normal street driving, set the boost engagement level to Level 3/MILD by moving the spring to position "3". Level 1/Aggressive, should only be used for race and track applications. Make sure engine is cool before making any adjustments.

#### 2011 and Up Applications



59. Remove the protective tape from the cylinder heads.
60. Carefully lower the supercharger onto the cylinder heads making sure to avoid the A/C lines. Connect the MAP Extension to the MAP Sensor on the rear of the manifold.
61. Apply silicone lube or equivalent, to the silicone portions of the supplied intake gaskets. This will prevent the gaskets from tearing during installation.

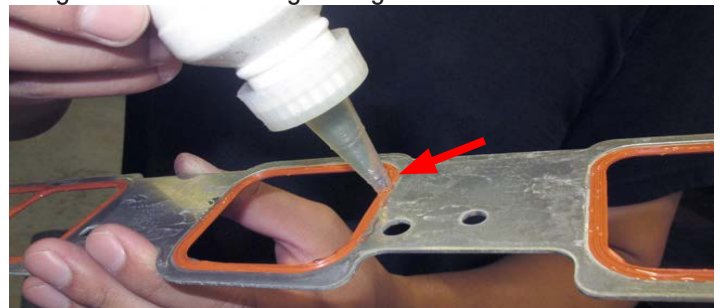

62. Carefully lift up the passenger side of the supercharger and slide the passenger side intake gasket into position and gently lower the supercharger. Repeat for the driver side.



63. Using a 10mm universal socket and the torque sequence below, install eight (8) M6 x 30mm manifold bolts from Bag #1. Torque all bolts to 9 ft-lbs using the same sequence.

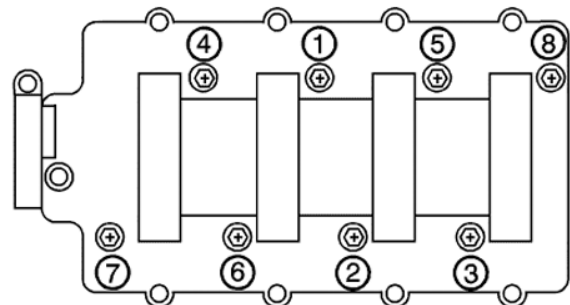

### Installation Instructions

64. Apply O-ring lube to the O-rings of the supplied fuel rail fittings. Install the straight fittings on the rear provisions of the rails. Install the 90° fitting on the front provision of the driver side rail and the plug in the front provision of the passenger side rail.

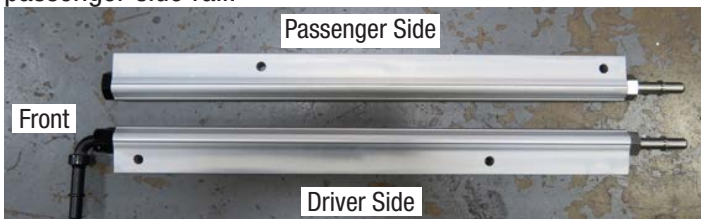

65. Apply O-ring lube to the upper O-rings of the supplied fuel injectors and install them onto the fuel rails with the connectors oriented away from the supercharger.

66. Apply O-ring lube to the lower O-rings of the fuel injectors, then install the driver side fuel rail by sliding the injectors down onto the manifold provisions and applying pressure until the mounting holes in the rails line up with the manifold.

**NOTE:** It may be necessary to remove the PCV/Oil Fill blocks in order to install the fuel rails. Ensure O-rings are properly seated before reinstalling the PCV/Oil Fill blocks. Torque bolts to 8ft-lbs.



67. Connect the fuel crossover hose to the straight fitting on the passenger side fuel rail. Route the fuel crossover behind the manifold as you install the passenger side fuel rail. Connect the fuel crossover to the straight fitting on the driver side rail.



68. Using a 10mm socket, secure the fuel rails to the manifold using four (4) M6 x 30mm bolts supplied in Bag #1. Reconnect all eight (8) fuel injector connectors.

69. Install the supplied fuel line to the 90° fitting on the driver side fuel rail and to the factory fuel feed line.



70. Remove the oil fill cap from the stock intake manifold and install it onto the supercharger.

71. Install the passenger side PCV hose onto the rear barb of the supercharger and then to the barb located on the passenger side of the snout.



72. Install the brake booster hose to the rear barb on the supercharger snout.





# Edelbrock E-Force Supercharger System 2009-'17 Dodge/RAM 5.7L Hemi 1500 Truck

## Installation Instructions

**NOTE:** Applications with driver side fender mounted EVAP solenoids proceed with Step 73 and skip Step 74-77.



73. Install the S/C to EVAP hose onto the front barb of the supercharger snout. Route the hose over towards the EVAP solenoid and connect it to the EVAP solenoid. Proceed to Step 78. *TIP: Straight fitting goes on supercharger, 45° fitting goes on EVAP solenoid.*

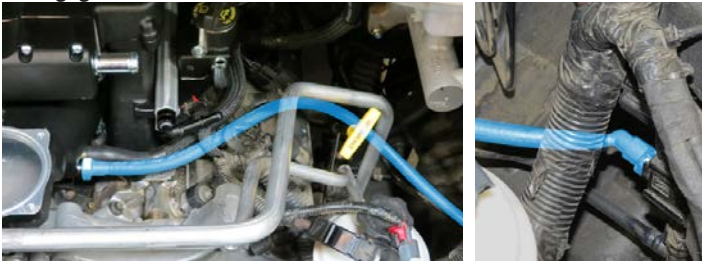

**NOTE:** Applications with manifold mounted EVAP solenoids proceed with Step 74-77. Disregard otherwise.



74. Using the M6 x 10mm bolt from Bag 2, install the supplied EVAP bracket to the front tab located on the passenger side of the supercharger. Secure the EVAP solenoid to the EVAP bracket as shown and connect the factory EVAP connector to the EVAP.



75. Locate the factory EVAP hose removed from Step 24.



76. Using a cutting tool, carefully split the EVAP hose to remove the quick connect fittings.



77. Install the factory quick connect fittings onto the supplied 1/2" hose. Connect the end with the straight fitting to the barb located on the firewall. Route the 90° end over towards the EVAP solenoid and connect to the solenoid.

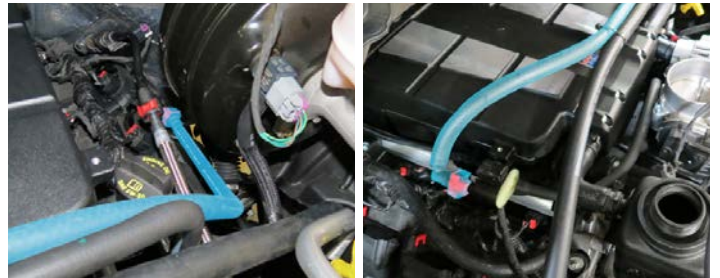



### Installation Instructions

78. Reinstall the alternator using the factory hardware.

**NOTE:** If the main power wire mounts to the rear of the alternator, it may be necessary to remove the locating tabs before reconnecting in order for the wire to reach. Attach a piece of protective conduit to the power wire where it makes contact with any other metal parts or sharp objects.



79. Install the 1/4" spacer from Bag #2 onto the stud left of the alternator.

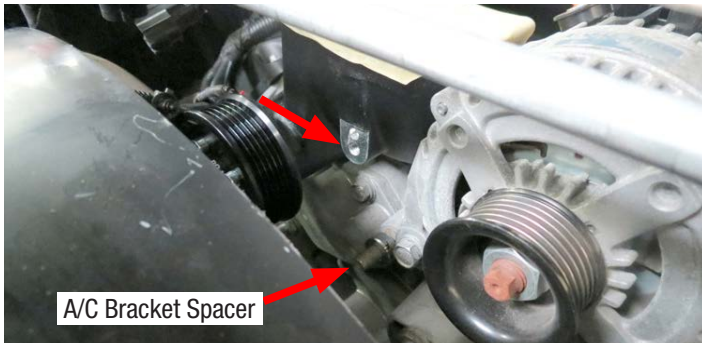

80. Use a 13mm socket to remove the factory idler pulley.



**NOTE:** Applications with Electronic Power Steering will use the supplied 90mm idler pulley. Applications with standard power steering will use the smaller 76mm idler pulley.

81. Apply blue thread locker onto the threads of the factory idler pulley bolt. Using the factory bolt, install the supplied idler pulley to the factory location and torque to 40 ft/ lbs.



82. Position the supplied drive belt around the A/C support bracket and install it using the belt routing diagram below. **TIP:** The diagram on the right is for applications with electric power steering.

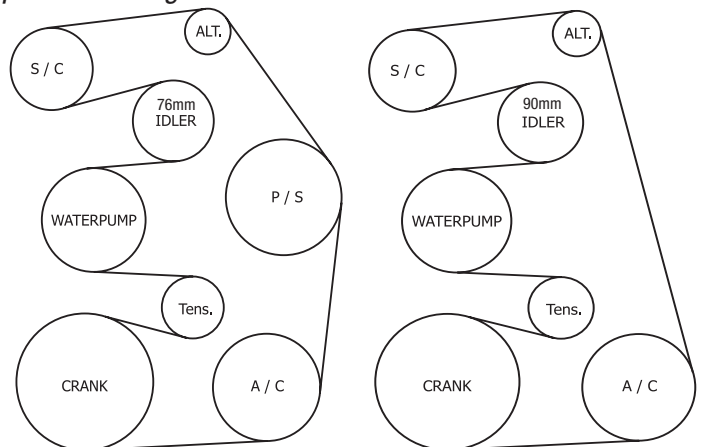

### Installation Instructions

83. Position the supplied A/C support bracket onto the stud and secure with a M10 Nut and M8 Button Head bolt from Bag #2. **NOTE:** The other provision is the upper mounting point located on the supercharger nose.

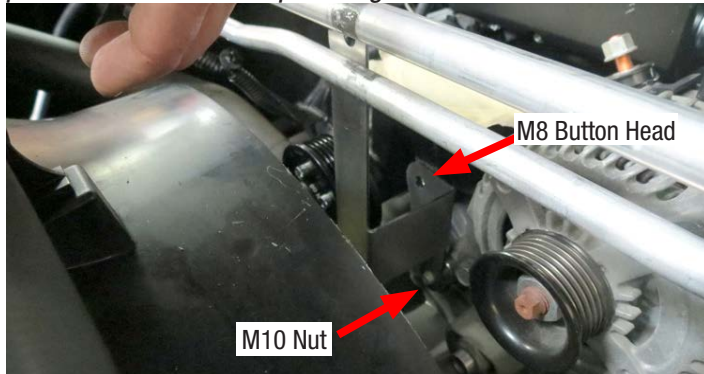

84. Mount the supplied bracket to the intercooler reservoir tank using four M6 x 10mm bolts supplied in Bag #3.



85. Using a 13mm socket, remove the water pump bolt left of the coolant temp sensor. The water pump bolt provision and the cylinder head provision are the mounting points for the recovery tank.

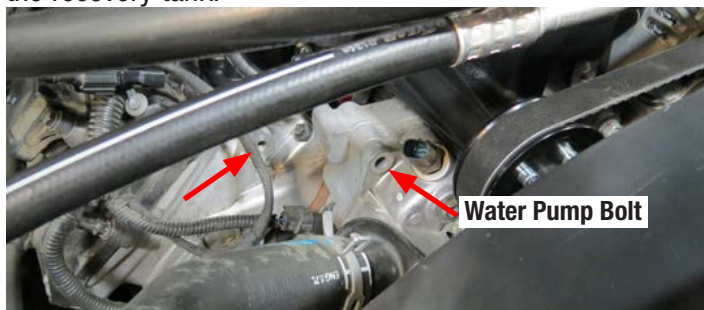

86. Using the supplied 1" spacer and M8 x 40mm bolt from Bag #2, mount the recovery tank assembly to the cylinder head provision. **NOTE:** If there is a coil resistor in this location from the factory, enlarge the hole on the resistor mounting tab and reinstall it over the intercooler reservoir bracket.

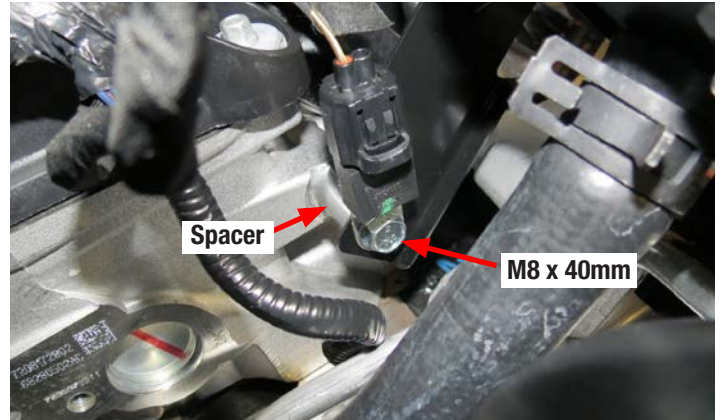

87. Using the factory water pump bolt, secure the recovery tank assembly to the water pump.



88. Using a 13mm socket, remove three (3) bolts next (passenger side) to the lower radiator hose. Install the supplied water pump bracket to this location using the factory bolts.

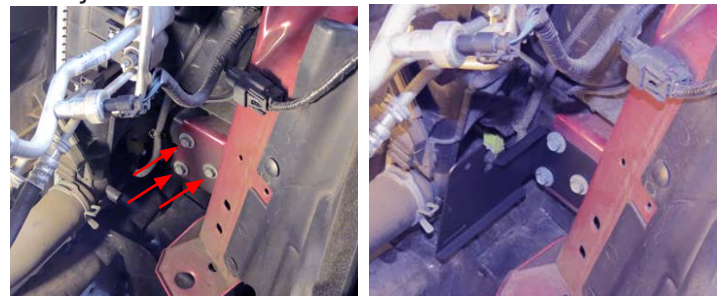

### Installation Instructions

89. Using the water pump bracket strap and M8 x 30mm bolt from Bag #2, loosely install the water pump so the outlet is pointing upwards.



**NOTE:** 2015 model years are equipped with active grill shutters. Proceed with Steps 90-93 to temporarily remove the shutters. If vehicle is not equipped with active grill shutters, please skip and proceed to Step 94.



90. Remove the hood latch cable from the top of the active grill shutters.

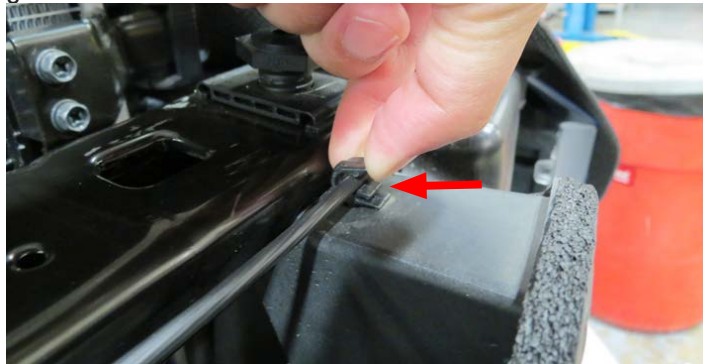

91. Using a 13mm socket, remove two (2) bolts securing the top of the active grill shutters.



92. Using a 10mm socket, remove two (2) bolts securing the bottom of the active grill shutters.



93. Unplug the active grill shutters' connector and remove the active grill shutter assembly. Proceed to Step 95.



### Installation Instructions

94. Using a 10mm socket, remove the horn assembly. Disconnect the assembly power connector and unclip the relay from the assembly. Set the horn assembly aside.

**NOTE:** Some model years will not have a relay and/or horn assembly.



95. Carefully position the Low Temp Radiator (LTR) in front of the A/C condenser as shown. DO NOT mount any brackets to the LTR yet.



96. Using a M6 x 10mm bolt and a Push Pin from Bag #2, loosely secure the upper passenger side LTR bracket to the LTR. Now secure the LTR bracket to the hole on the front railing with the Push Pin.

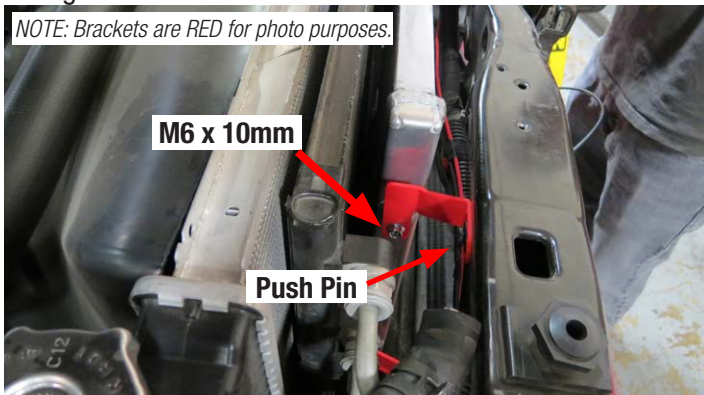

97. Using a M6 x 12mm bolt from Bag #2, loosely secure the relay assembly and the driver side LTR bracket to the LTR. Secure the LTR bracket to the hole on the front railing with a Push Pin from Bag #2.

**NOTE:** Earlier model years will not have a relay assembly. If this is the case, use a M6 x 10mm bolt instead of the M6 x 12mm bolt.

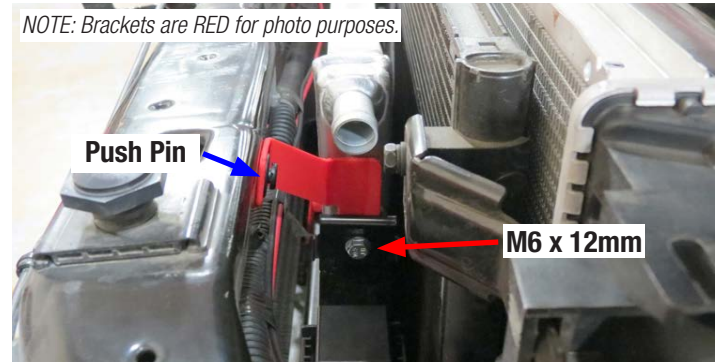

98. Remove the lower passenger side bolts securing the auxiliary cooler. Position the Lower Passenger side LTR bracket behind the auxiliary cooler bracket and loosely secure it using the factory bolt. Using a M6 x 10mm bolt from Bag #2 loosely secure the LTR bracket to the LTR.

**NOTE:** Some applications will not have the auxiliary cooler. However, bracket mounting locations will be the same.

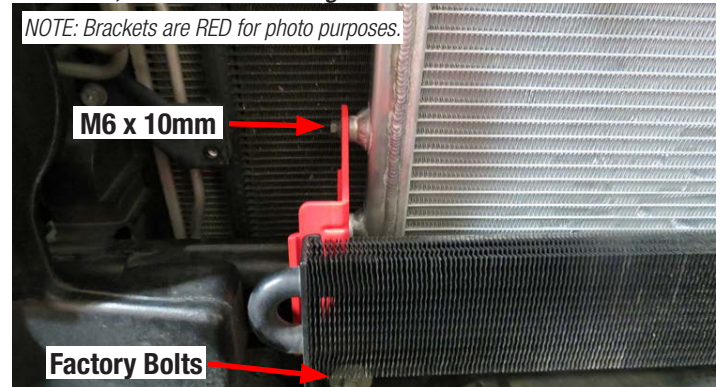

99. Align the LTR as needed and securely fasten all LTR bolts.

### Installation Instructions

100. Install the Recovery Tank to Manifold hose onto the outlet barb of the manifold and to the inlet barb on the recovery tank. Secure the hose using two (2) 3/4" hose clamps from Bag #2.



101. Using a 3/4" hose clamp from Bag #2, secure the Recovery Tank to Water Pump hose to the outlet barb of the recovery tank. Route the hose down towards the water pump.



102. Using a 3/4" hose clamp from Bag #2, secure the Recovery Tank to Water Pump hose (BLUE) to the inlet barb of the water pump. Using a 3/4" hose clamp from Bag #2, secure the Water Pump to LTR hose (ORANGE) to the outlet barb of the water pump and route up towards the LTR.



103. Using a 3/4" hose clamp from Bag #2, secure the Water Pump to LTR hose to the inlet barb of the LTR.



104. Using a 3/4" hose clamp from Bag #2, secure the Manifold to LTR hose to the inlet barb on the manifold.



105. Route the other end of the Manifold to LTR hose towards the front of the vehicle and secure it to the LTR using a 3/4" hose clamp from bag #2.



### Installation Instructions

106. Reinstall the horn assembly and/or Active Grill Shutter if applicable.

107. Reinstall the factory grill assembly.

108. Install the supplied throttle body O-ring to the manifold and install the throttle body using four (4) M6 x 50mm bolts from Bag #1.



109. Connect the supplied Throttle Body Extension harness to the factory throttle body connector and to the throttle body.



110. Connect the IAT Extension harness to the factory IAT connector and to the IAT sensor on the rear of the manifold.

**NOTE:** Two IAT Extension harnesses are supplied, use the appropriate one for your application.



111. Find an appropriate mounting location for the water pump harness relay. Make sure the location provides adequate wire lengths to the battery terminal. A good location is the bolt securing the fuse box assembly.

**NOTE:** Depending on model year, this location may not be accessible.

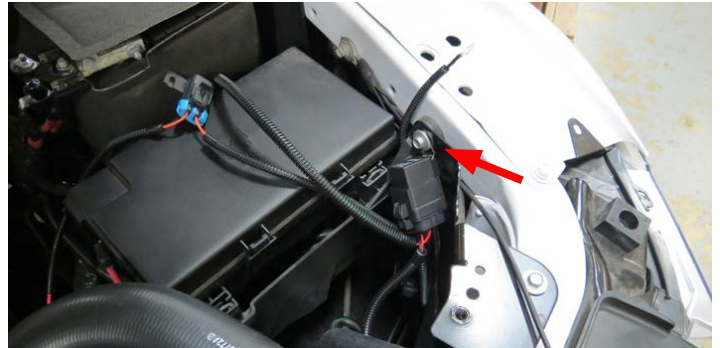

112. Connect the RED wire (+12V) on the water pump harness to a +12V CONSTANT power source. Depending on model year, this can be either the battery terminal or the terminal located in the fuse box.

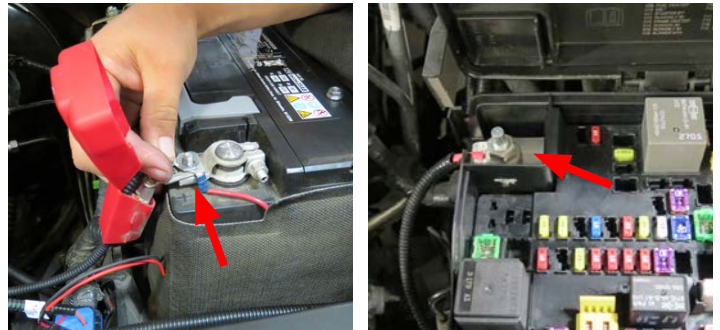

113. Using a 10mm socket, mount the GROUND (BLACK wire) on the water pump harness to the chassis ground right of the fuse box.



### Installation Instructions

**NOTE:** The fuse tap on the water pump harness must be installed to a Key On, 20A, power source located in the fuse box. Most model years will use the **IGN R-Front Seat/Vent, slot M8 or M35**. Newer applications will use the **Cigar Lighter slot F93**. **TIP:** See reverse of fuse box cover for appropriate location.

114. Remove the factory 20A fuse from the appropriate fuse slot and install it to the bottom slot of the supplied fuse tap. Install the supplied 10A fuse in the top slot and install the fuse tap into the slot previously occupied by the stock fuse.

**NOTE:** Applications with Micro2 type fuses will need to remove the fuse tap on the water pump harness and install the supplied Micro2 fuse tap. **TIP: Make sure to notch the fuse box as needed to not cut the wire when closing the fuse box lid.**

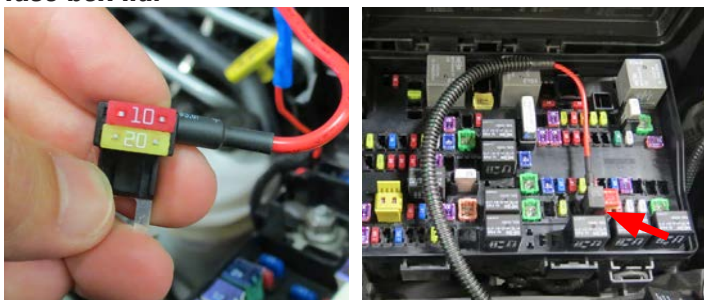

115. Route the water pump connector towards the front of the vehicle, along existing vehicle harnesses, and over towards the water pump. Secure water pump harness to existing vehicle harnesses with wire ties every 8-10 inches.

**TIP:** Route water pump connector in front of the LTR, following the existing vehicle harness for the horn assembly.

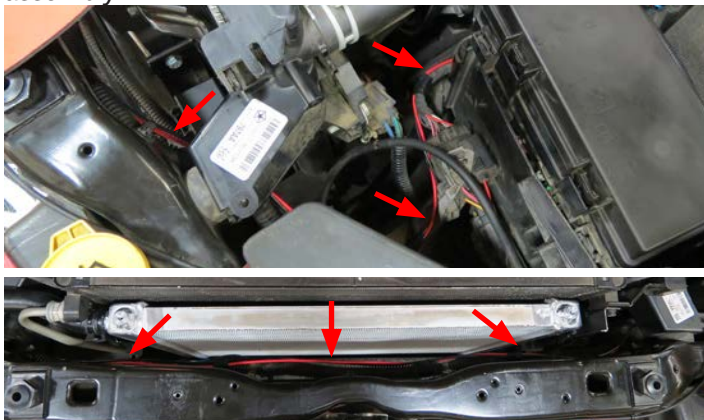

116. Remove the lid from the airbox and replace the factory air filter with the supplied green filter. Reinstall the airbox lid.



117. Connect the driver side PCV/Airbox hose to the barb on the oil fill neck and to the airbox as shown.



118. Install the supplied air intake tube and secure it to the throttle body and the factory airbox using the supplied couplers and worm clamps.



119. Remove the plastic A/C line support from the factory A/C line support bracket.



120. Using a M8 Nut from Bag #2, secure the plastic A/C line support to the previously installed A/C line bracket.



121. Reconnect the Negative battery terminal if not already done so.

122. This concludes the supercharger installation procedure.

**2009-2014 Vehicles:** If you have not flashed the ECM, do so by following Steps 1-13 at the beginning of these instructions; otherwise proceed to Step 123.

**2015+ Vehicles:** If you have not reinstalled a recalibrated ECM, do so by reversing the removal process; otherwise proceed to Step 123.

DO NOT proceed if the ECM has not been flashed or reinstalled.

123. Turn the ignition on but do not start the vehicle. Check for any fuel, coolant or power steering fluid leaks (if applicable). If leaks are present, shut the ignition off immediately and repair leaks before continuing.

124. Start the engine and let it come up to operating temperature, then shut it off and recheck all fluid levels. Top fluids off necessary.